



Fog Lights (Kit P/N 219 400 348)

The following symbols may be used in this document:

WARNING	
Indicates a hazardous situation which, if not avoided, could result in death or serious injury.	

CAUTION Indicates a hazard situation which, if not avoided, could result in minor or moderate injury.

NOTICE Indicates an instruction which, if not followed, could severely damage vehicle components or other property.

WARNING	
<ul style="list-style-type: none"> – For safety reasons, this kit must be installed by an authorized BRP dealer. – This kit is designed for specific applicable models only (authorized BRP dealers will confirm model(s)). It is not recommended for units other than the one (those) for which it was sold. – This instruction sheet MUST be given to the purchaser. – Should removal of a locking device (e.g. lock tabs, self-locking fasteners, etc.) be required when undergoing disassembly/assembly, always replace with a new one. – Torque wrench tightening specifications must strictly be adhered to. 	











NOTE: The illustrations in this document show typical construction of the different assemblies and may not reproduce the full detail or exact shape of the parts; however, they represent parts that have the same or similar function.

Installation time is approximately **1.0** hour.

ICON LEGEND

ICON	INDICATES
	Parts to be discarded

PARTS TO BE INSTALLED

ITEM	DESCRIPTION	PART NUMBER	QTY
P1	Assembled Fog Light Package 	710 001 275	1
P2	Fog Light Adaptor 	Not Available Separately	1
P3	LH Fog Light Bezel 	705 001 469	1
P4	RH Fog Light Bezel 	705 001 470	1
P7	Switch (Spyder ST) 	710 002 351	1
P8	Switch (Spyder RS) 	710 001 277	1
P8a	Four Pin Connector 	Not Available Separately	1
P8b	Switch Nut 	Not Available Separately	1
P9	Console Decal (Spyder RS) 	704 901 383	1
P10	M8 x 25 Torx Screw 	207 682 544	4
P11	M8 Housing Nut 	269 501 943	4
P12	Wiring Harness with Relay 	710 003 216	1
P13	Clip 	414 479 100	12

INSTALLATION INSTRUCTIONS

Unless when specified, installation procedure is the same for both sides.

Vehicle Preparation

Spyder ST Models

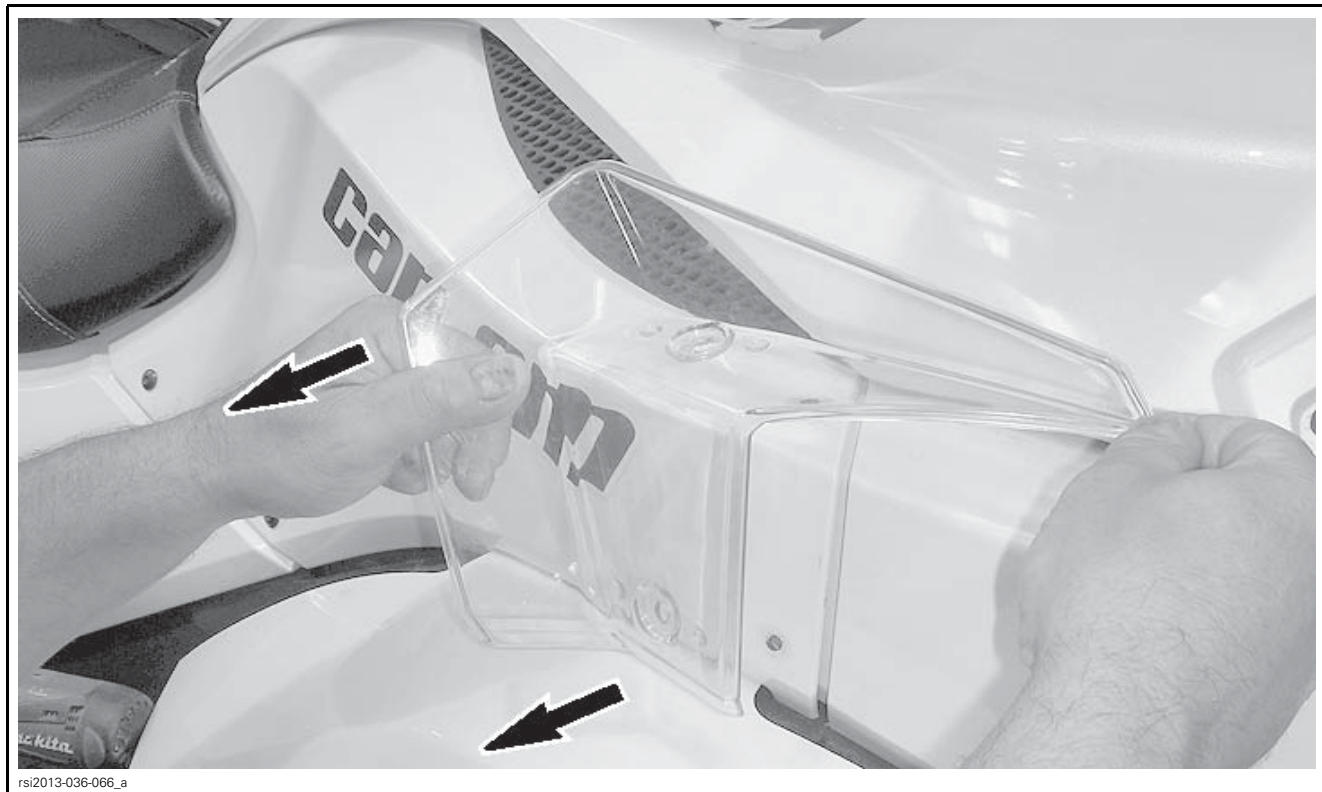

Spyder RS Models

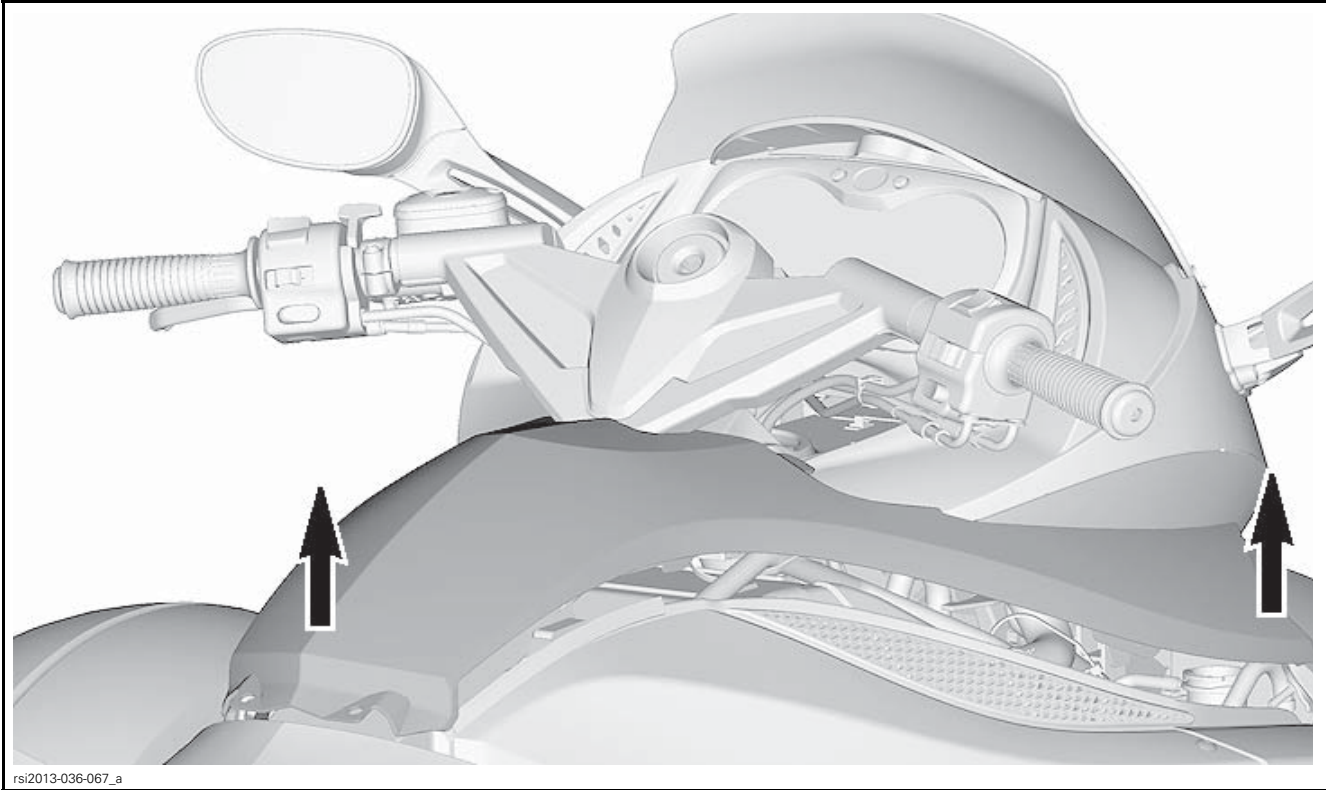

All Models

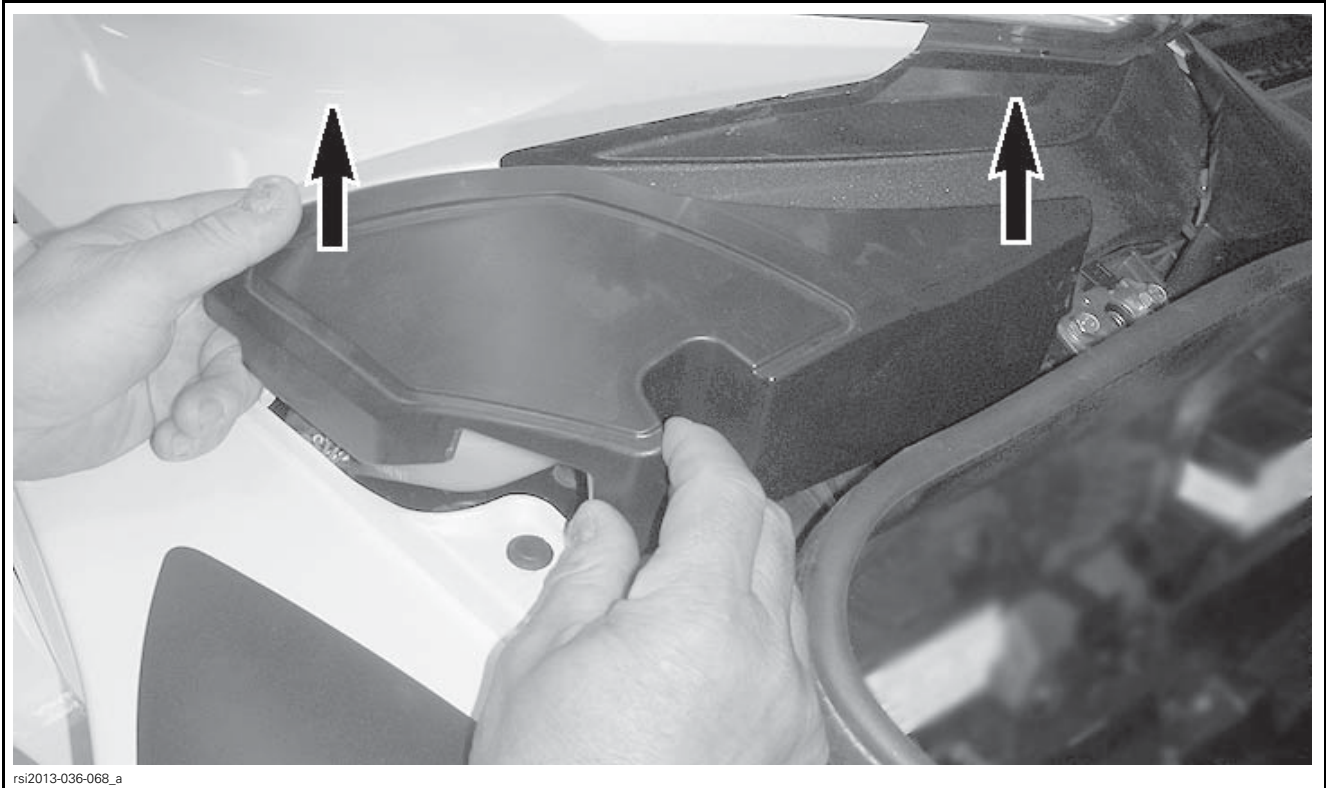

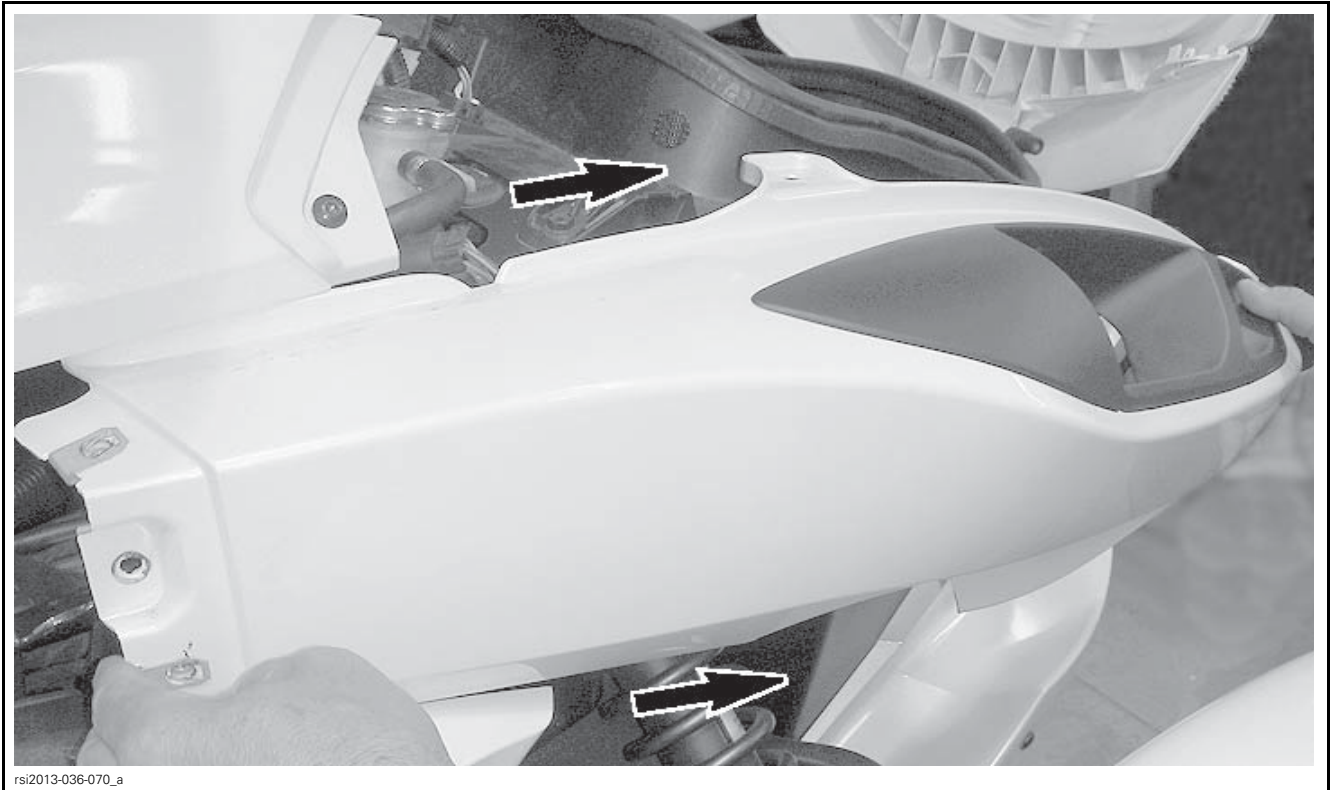

Fog Light Installation

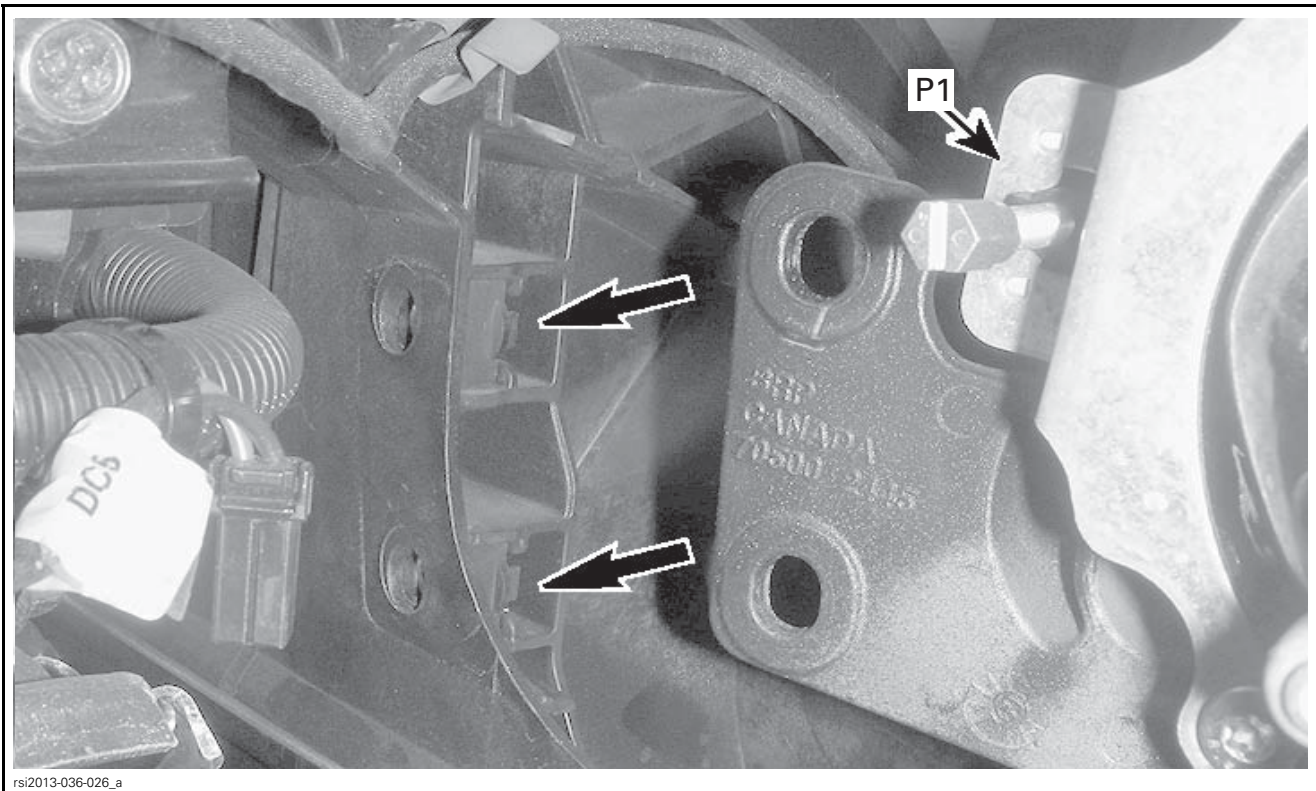
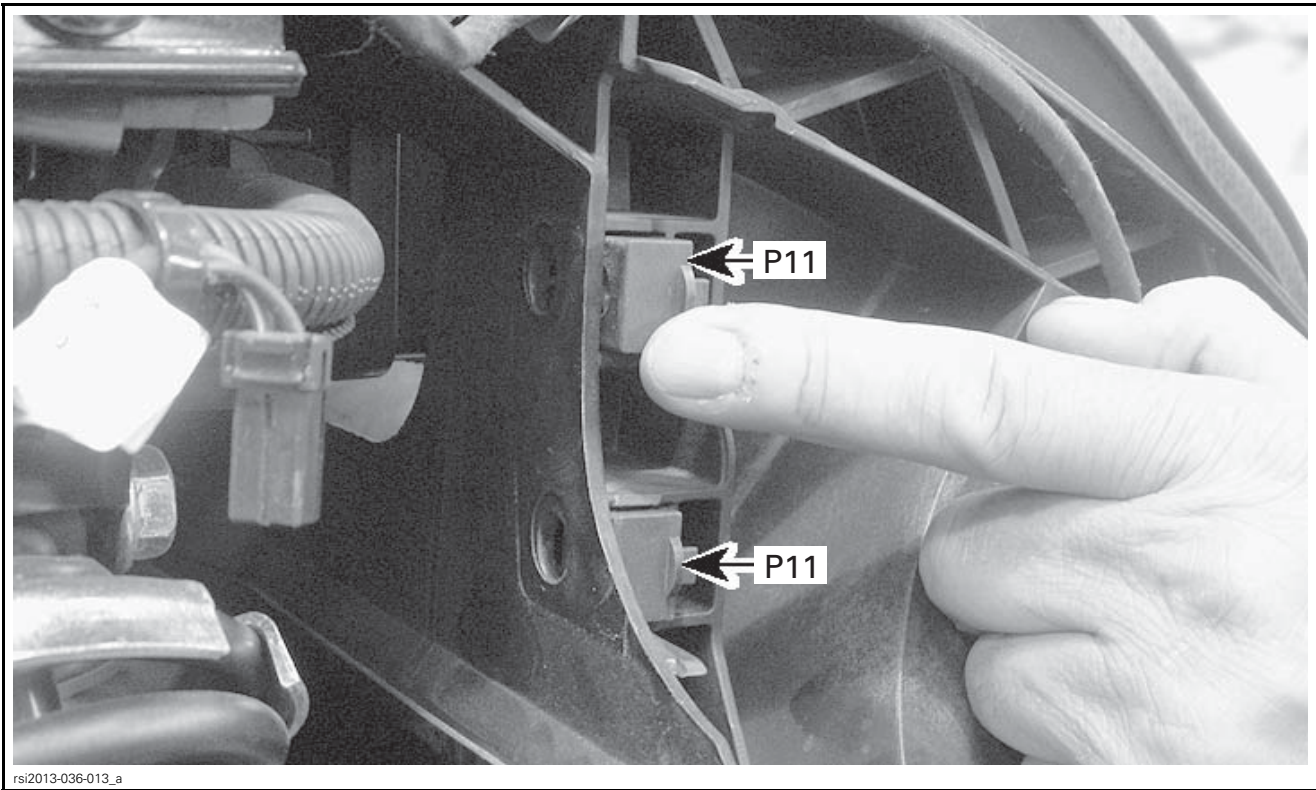

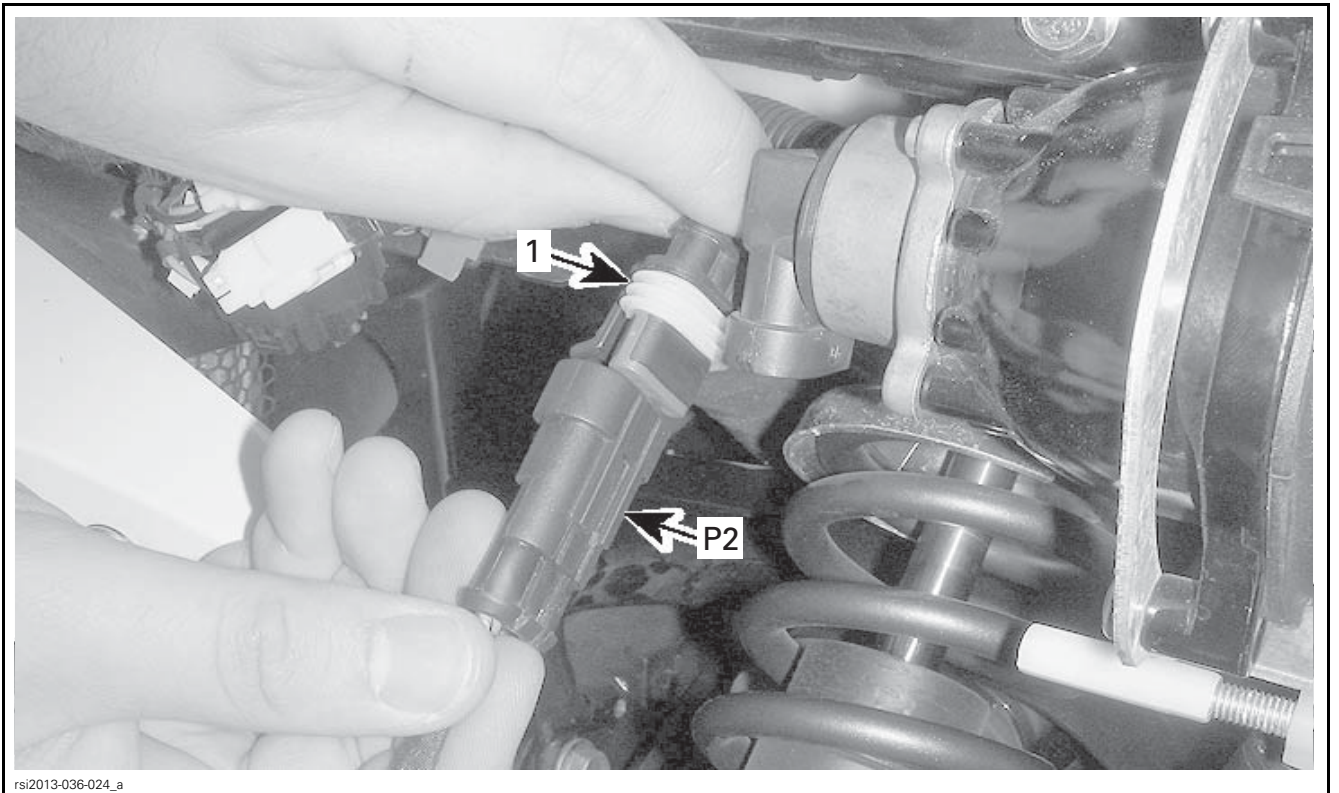
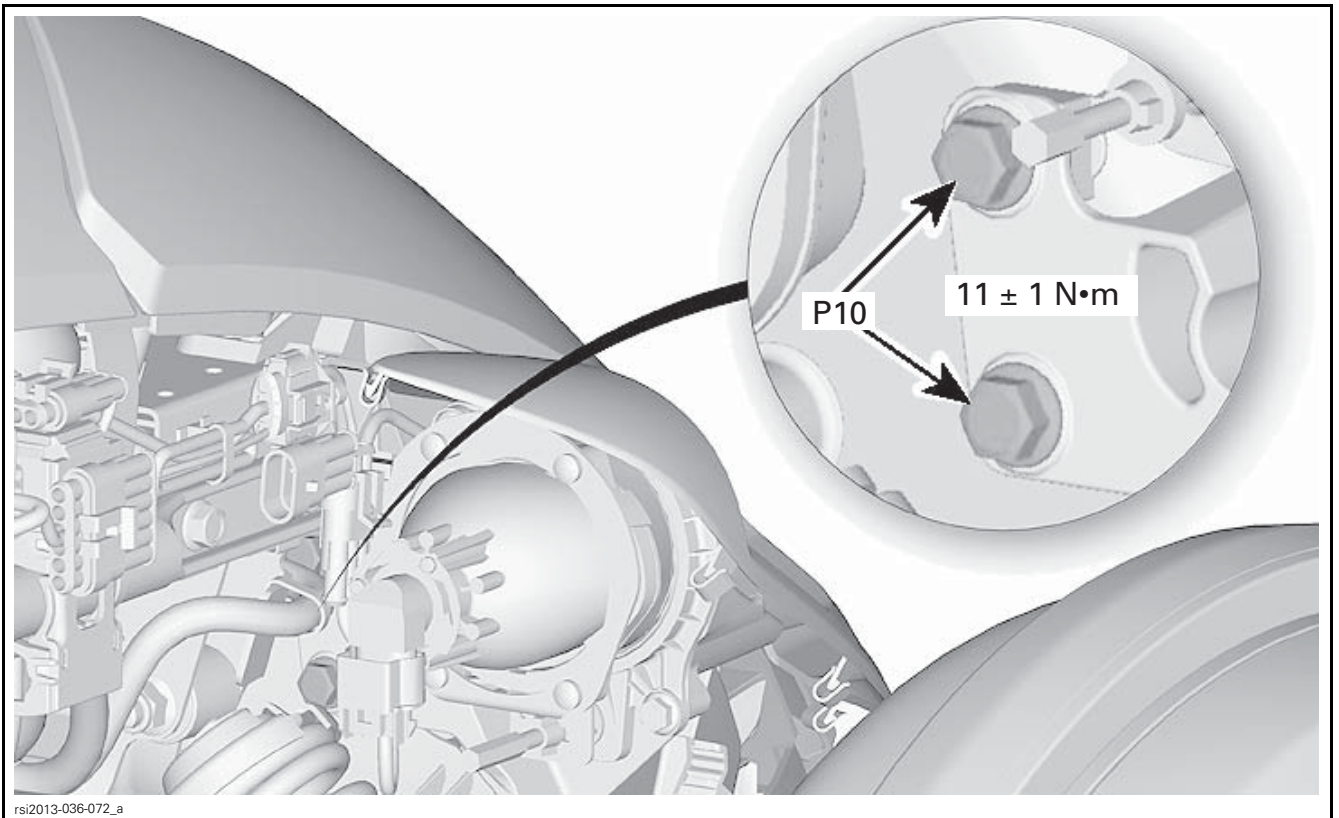

1. Vehicle main harness

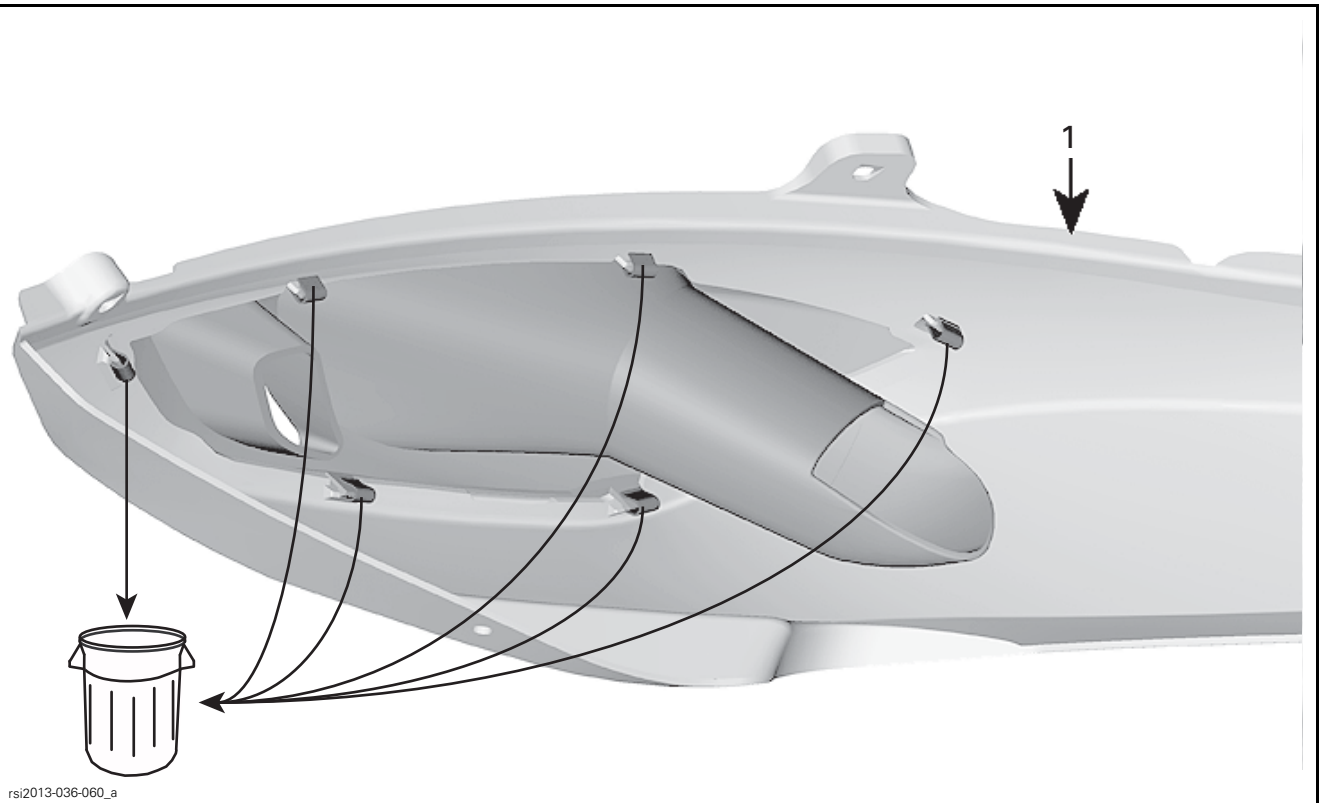
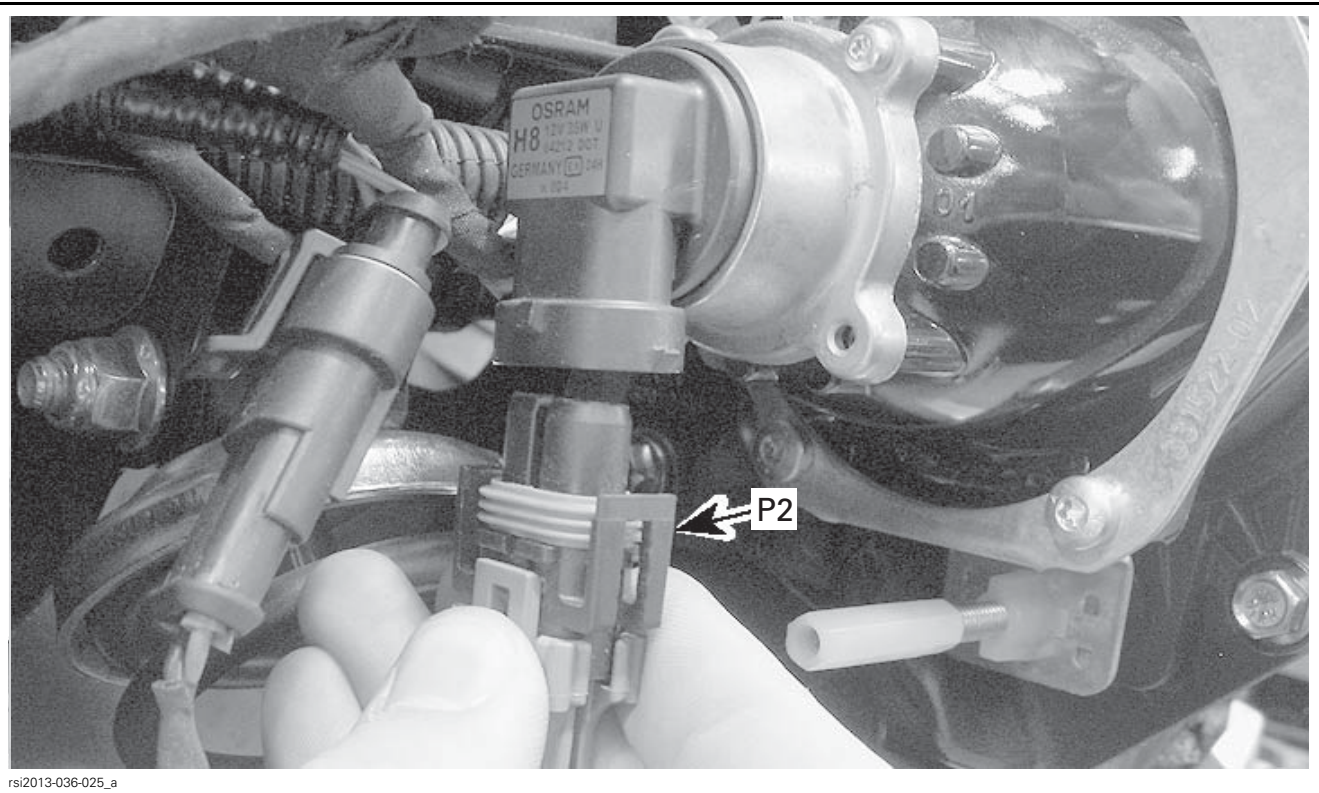

1. RH front side panel

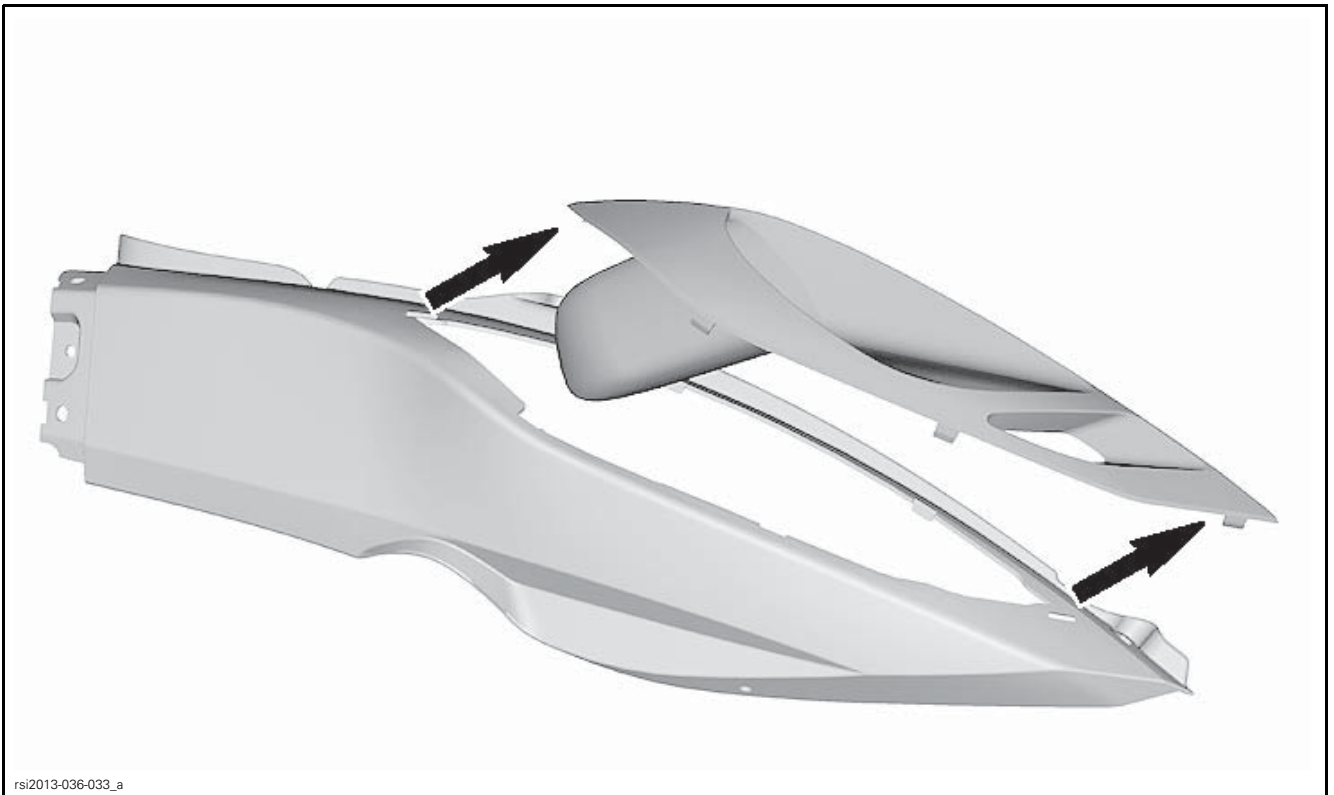

rsi2013-036-033_a

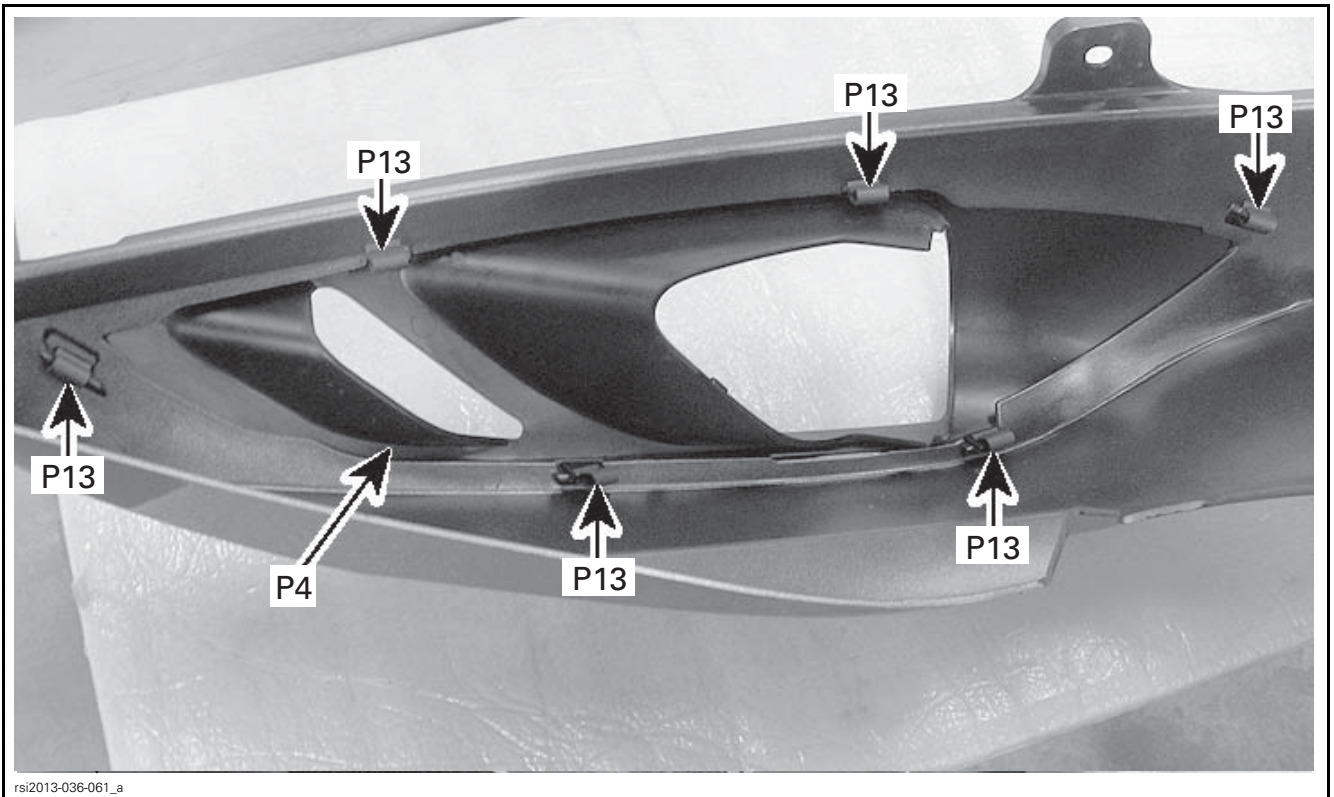

rsi2013-036-061_a

Fog Light Switch Installation

Spyder ST Models

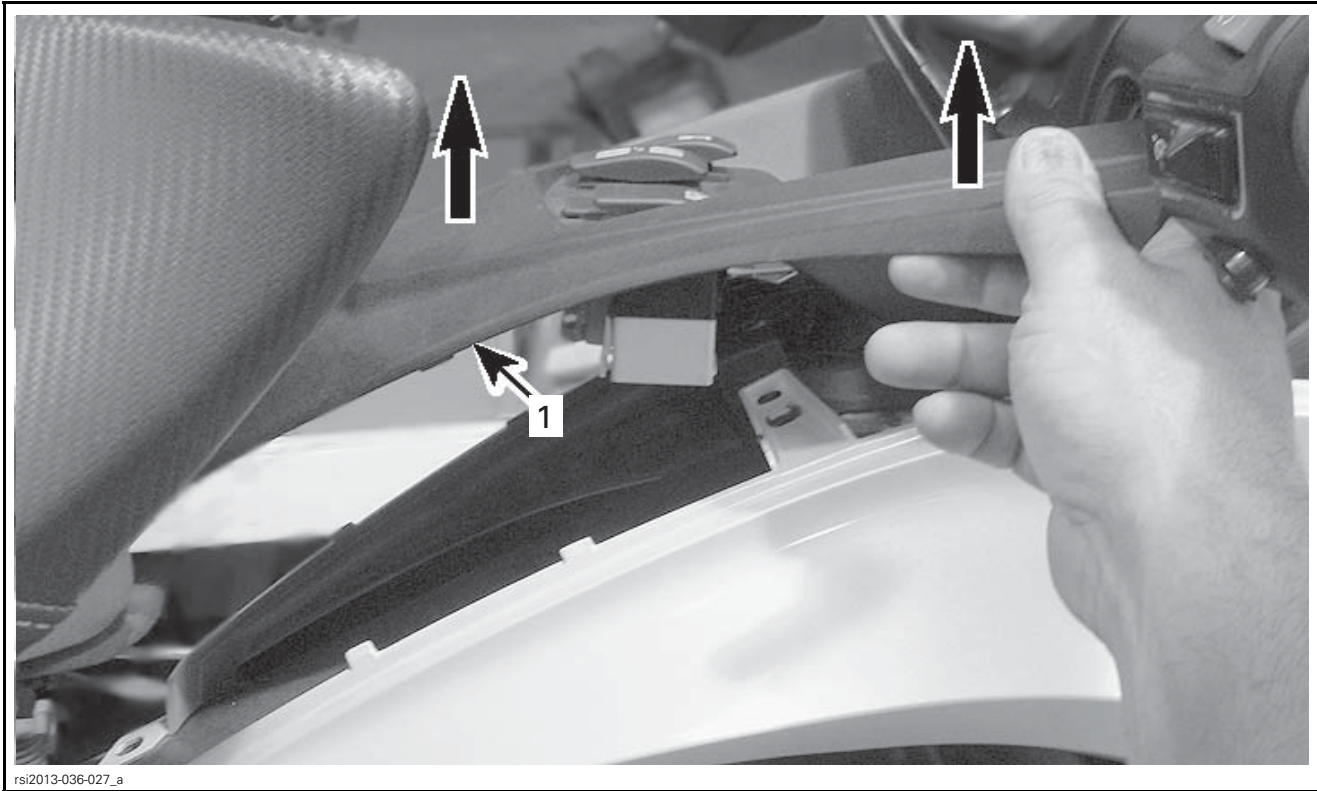

1. Console

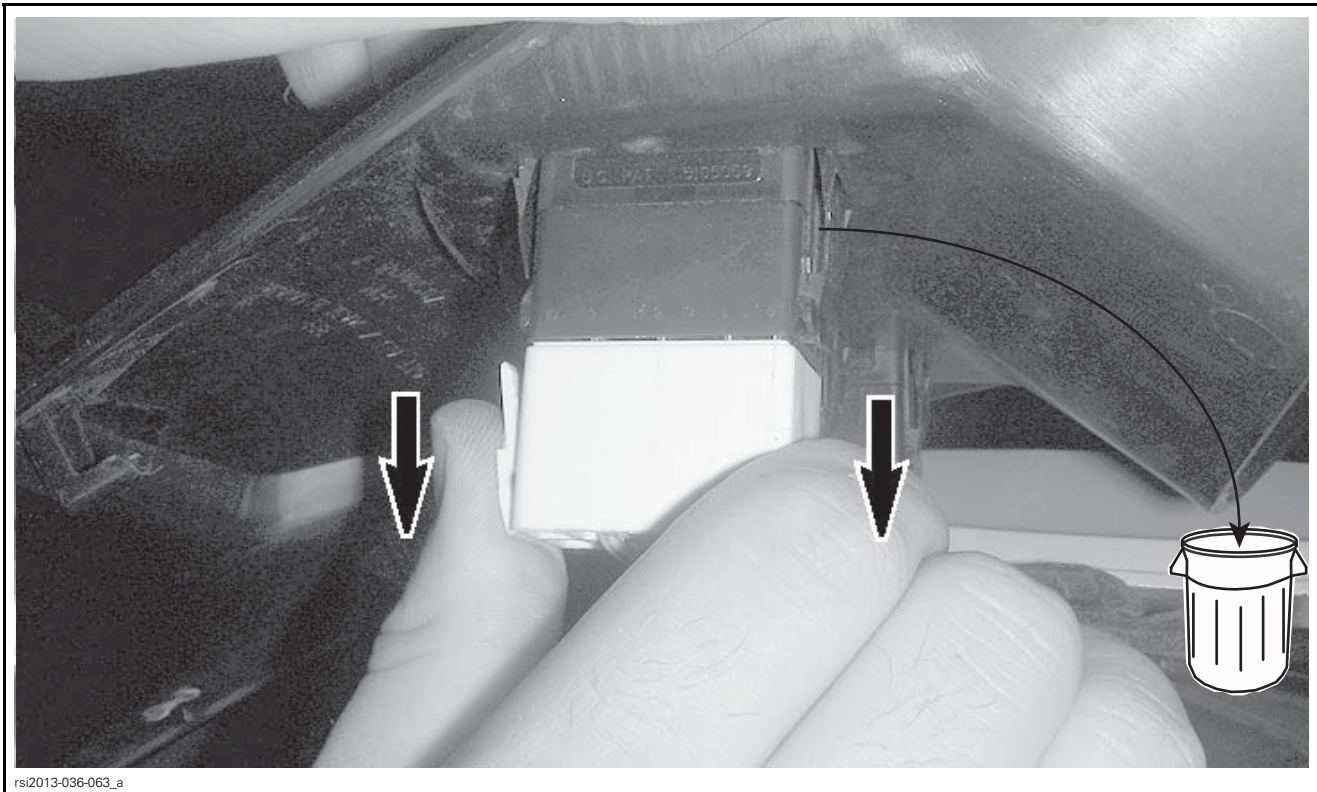

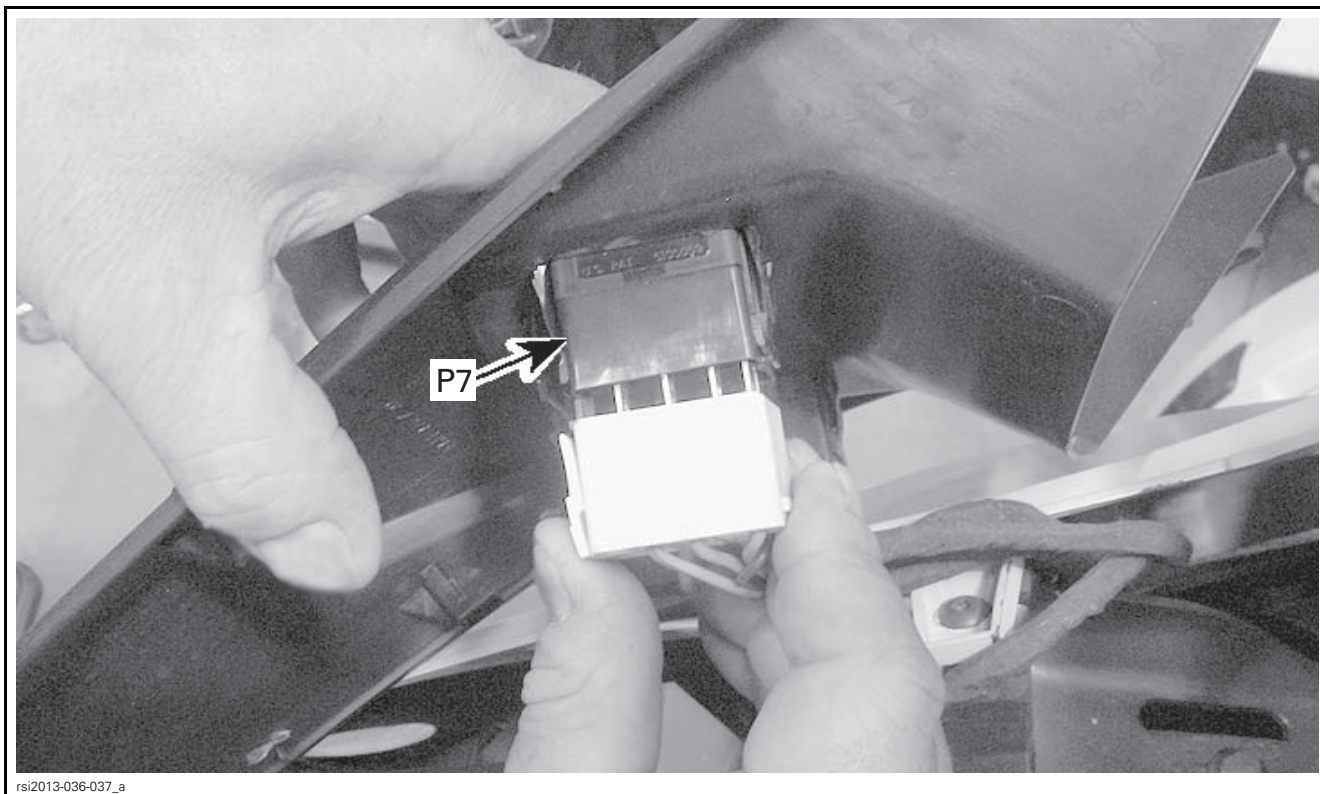
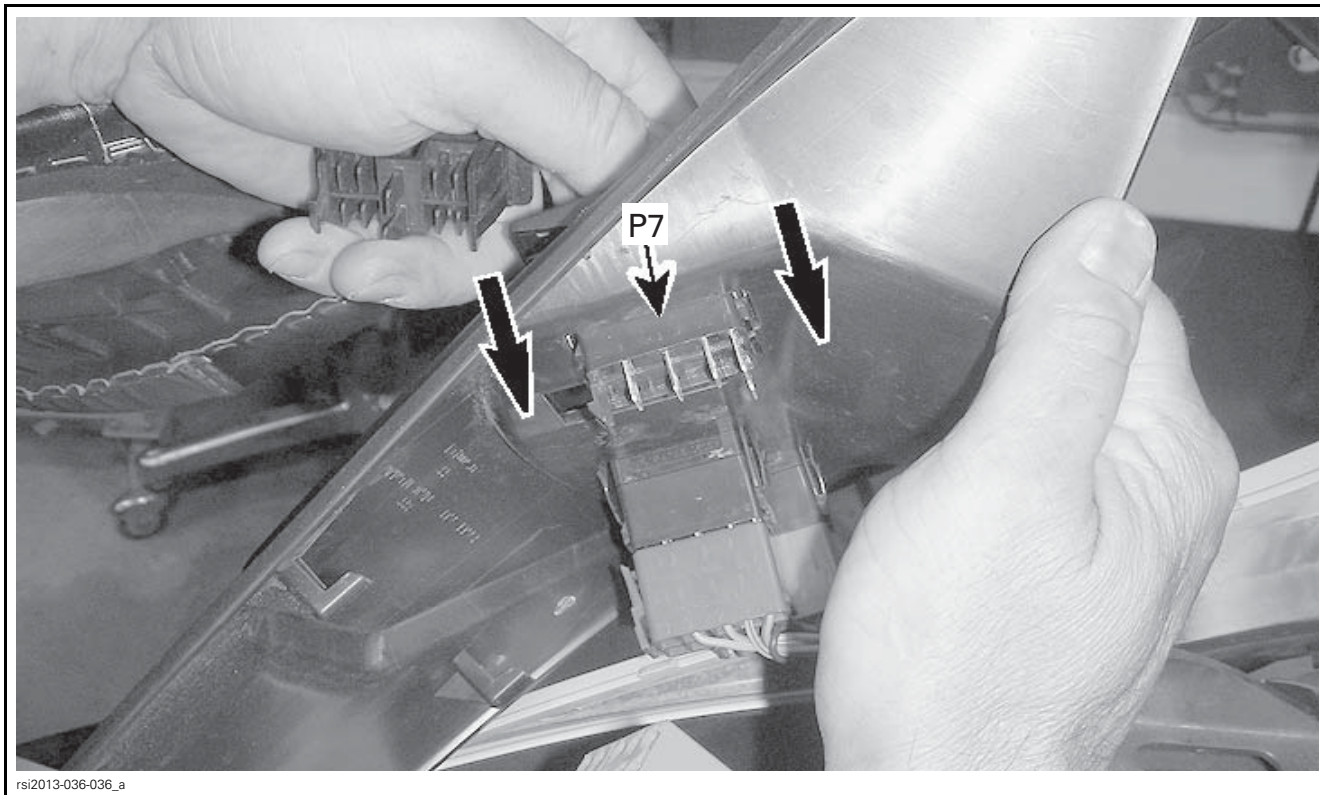

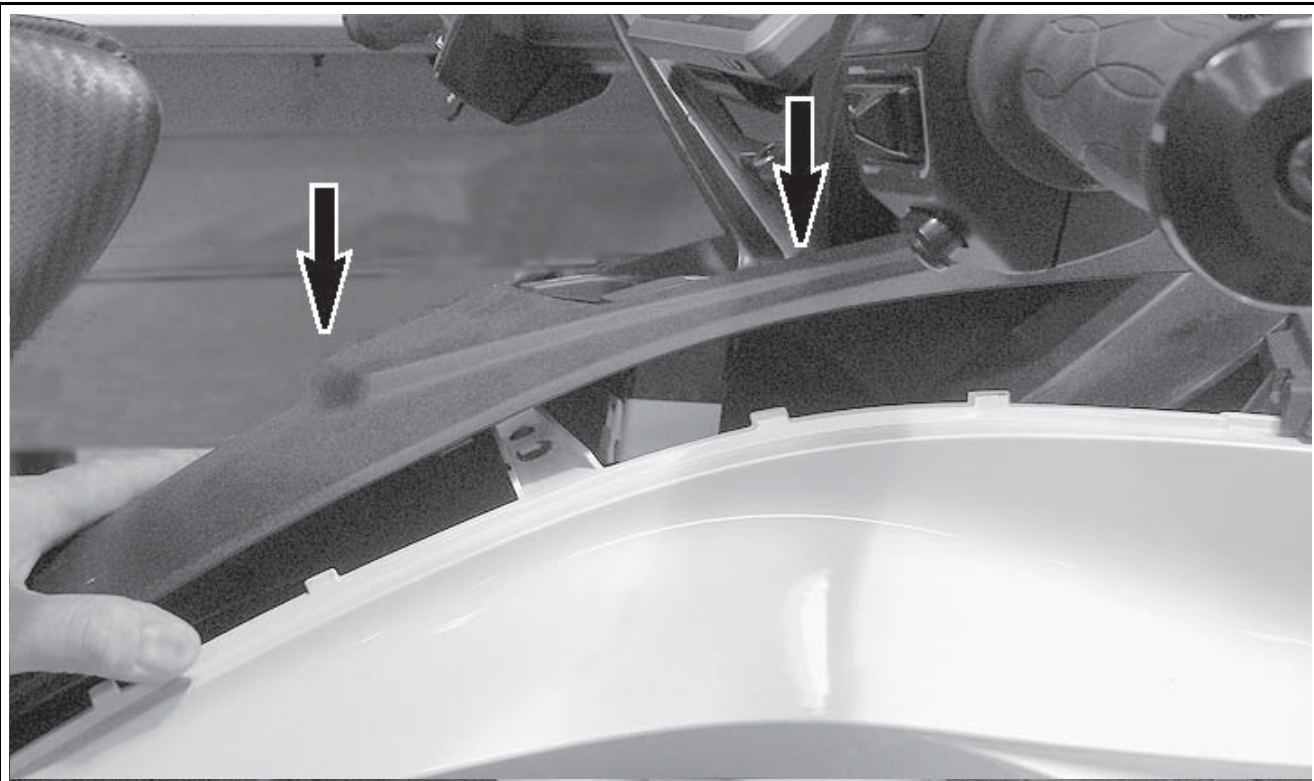

rsi2013-036-038_a

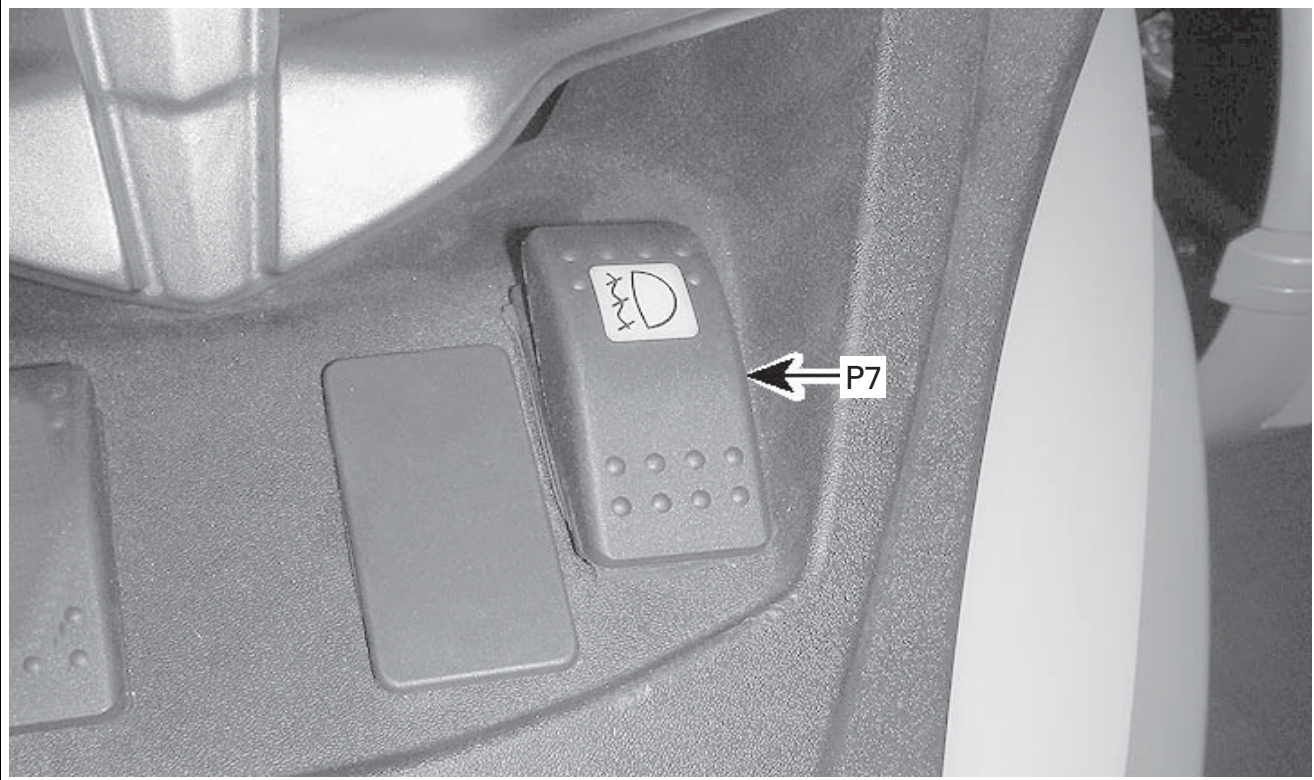

rsi2013-036-039_a

Spyder RS Models

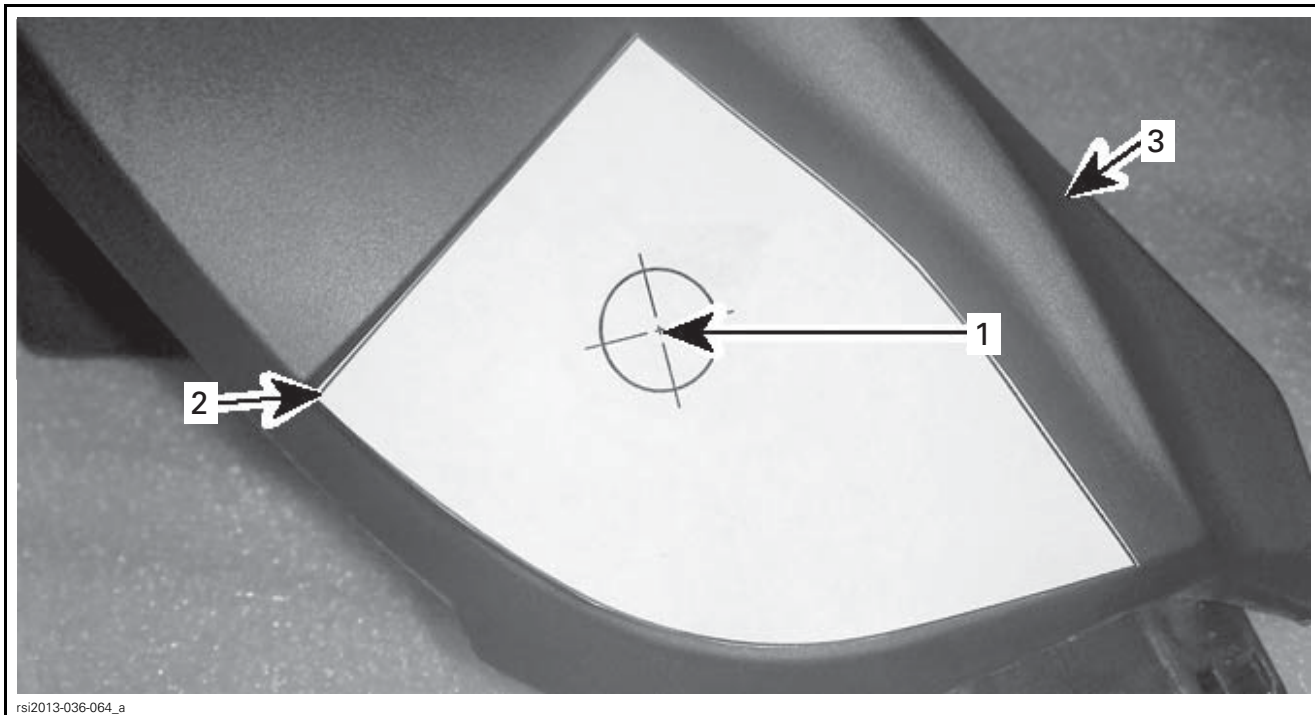

rsi2013-036-064_a

1. Where to drill
2. Provided template
3. LH rear extension of console panel

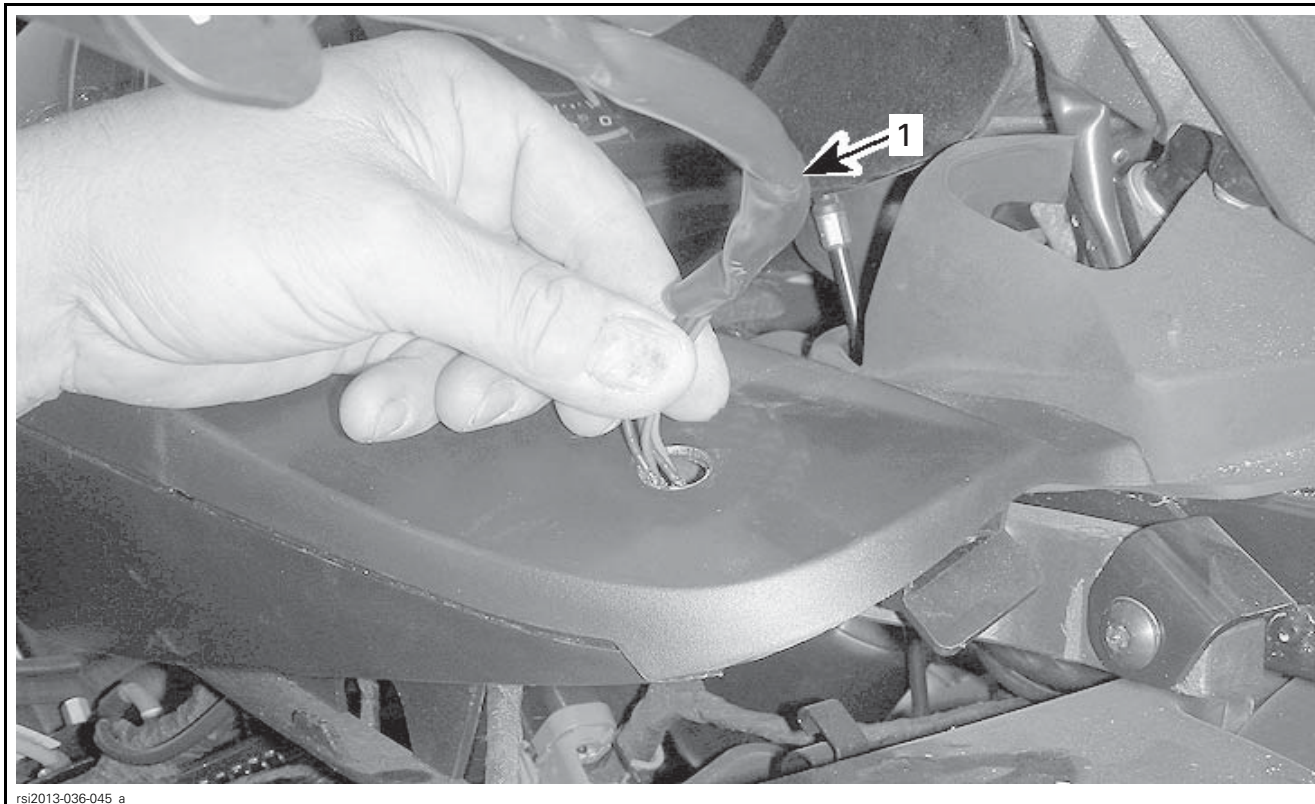

rsi2013-036-045_a

1. Switch harness

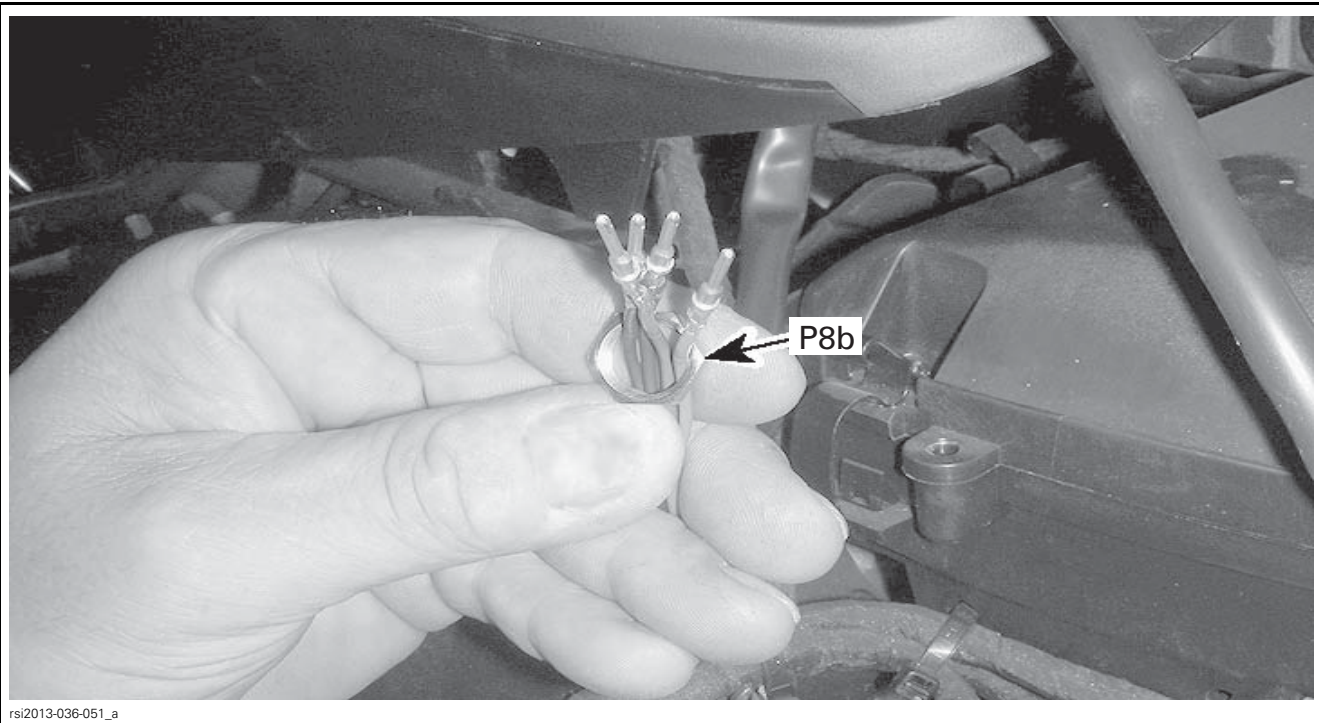

rsi2013-036-051_a

NOTE: Make sure switch nut [P8b] is well tightened underneath console.

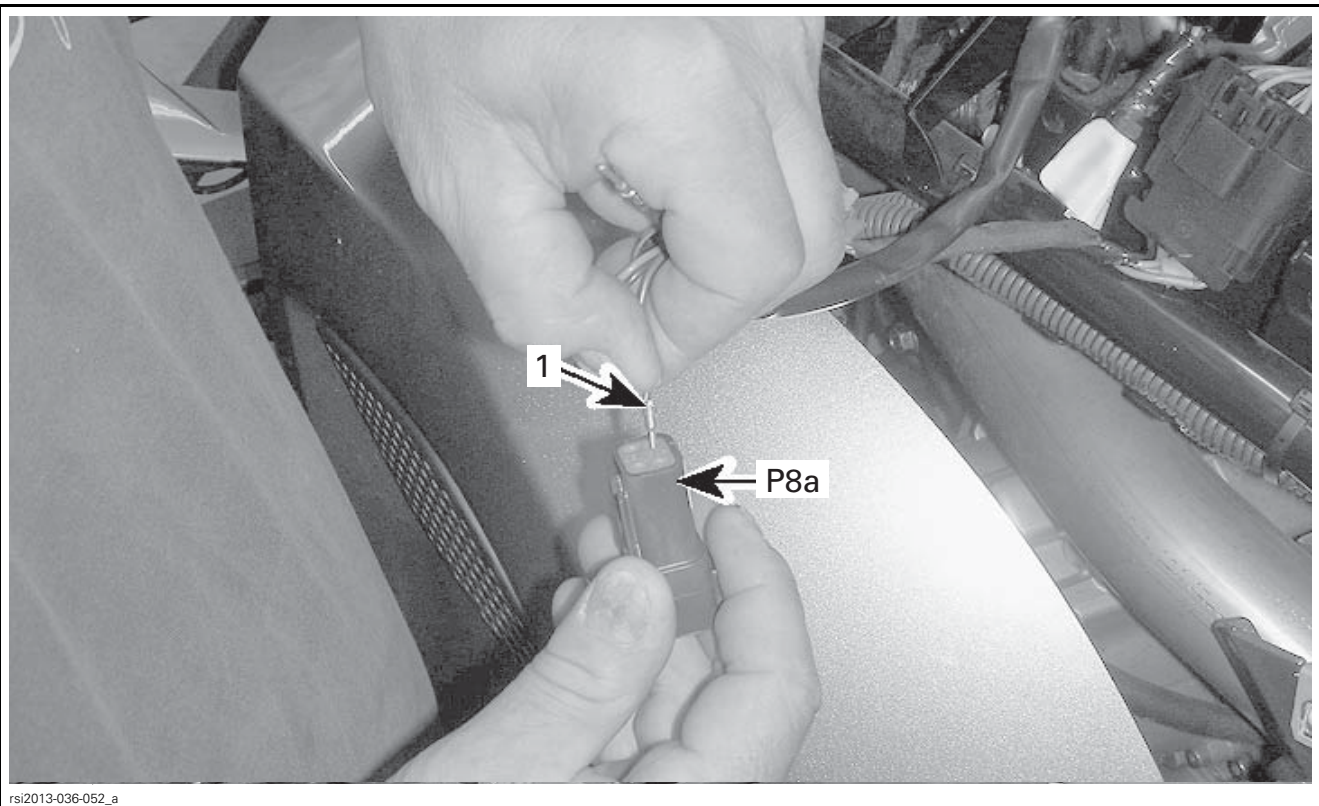

rsi2013-036-052_a

1. Switch harness

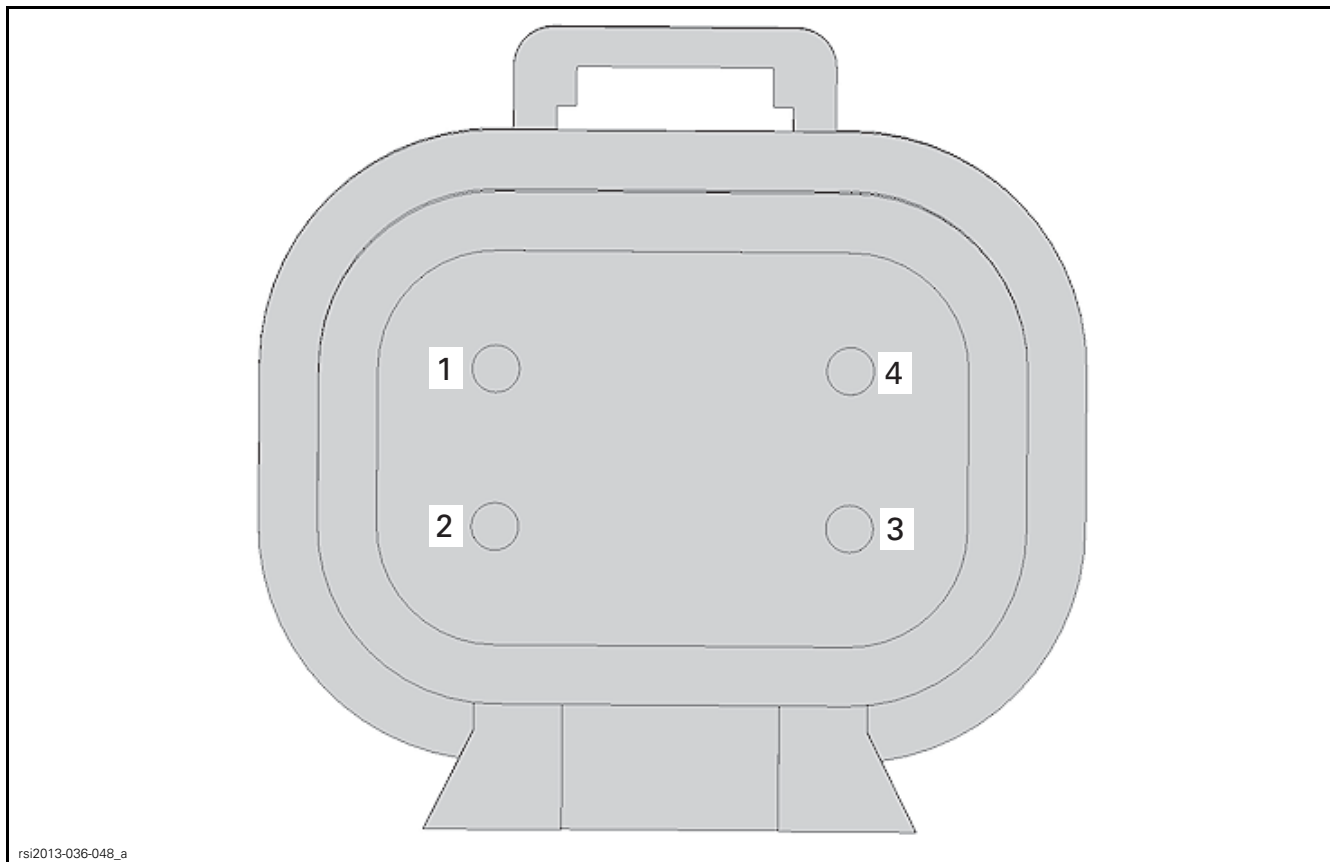

rsi2013-036-048_a

- 1. BLUE
- 2. BLACK
- 3. BLACK
- 4. RED

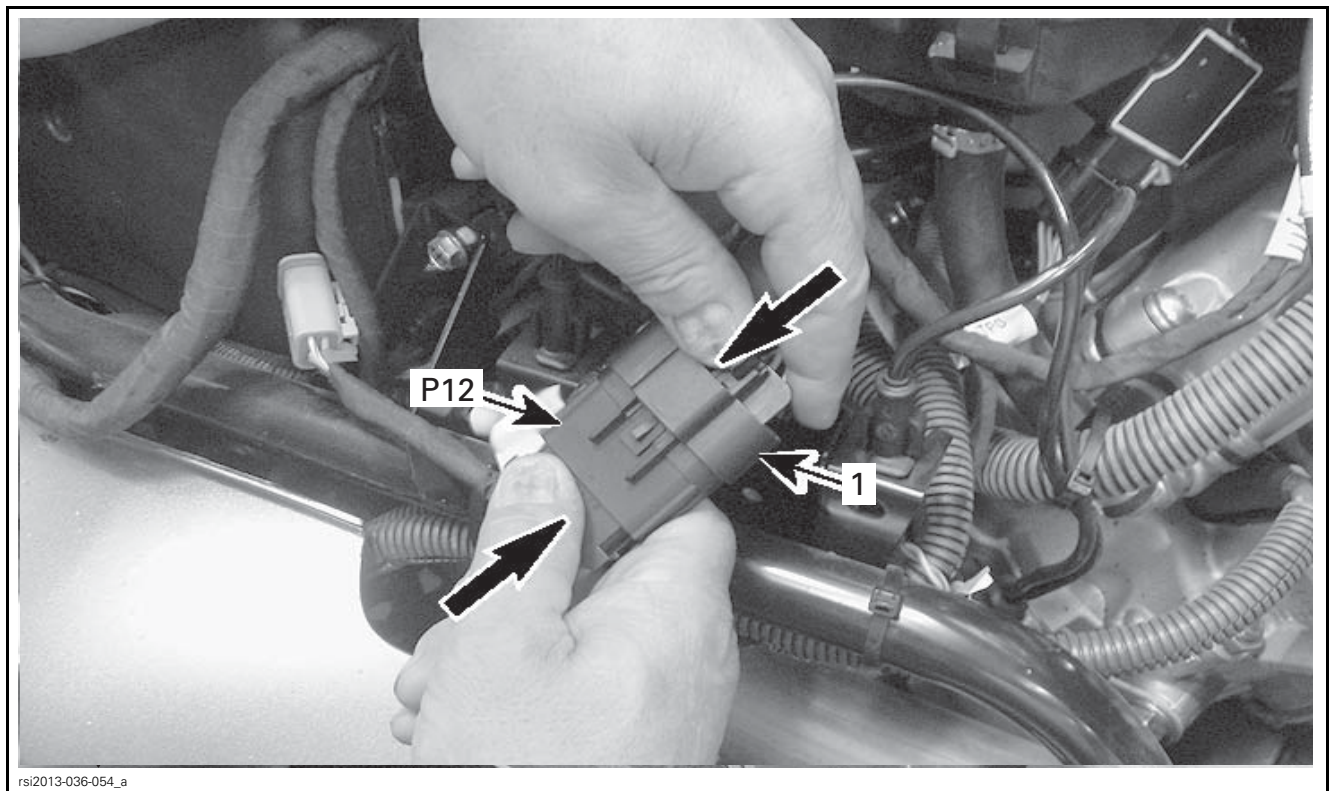

rsi2013-036-054_a

- 1. Vehicle main harness

NOTE: Both black wires are interchangeable but cannot be connected together as one. The switch [P8] function and the light function of the fog switch/light assembly must remain isolated from each other. LED in switch will illuminate only when switch is depressed (fog lights turned "ON").

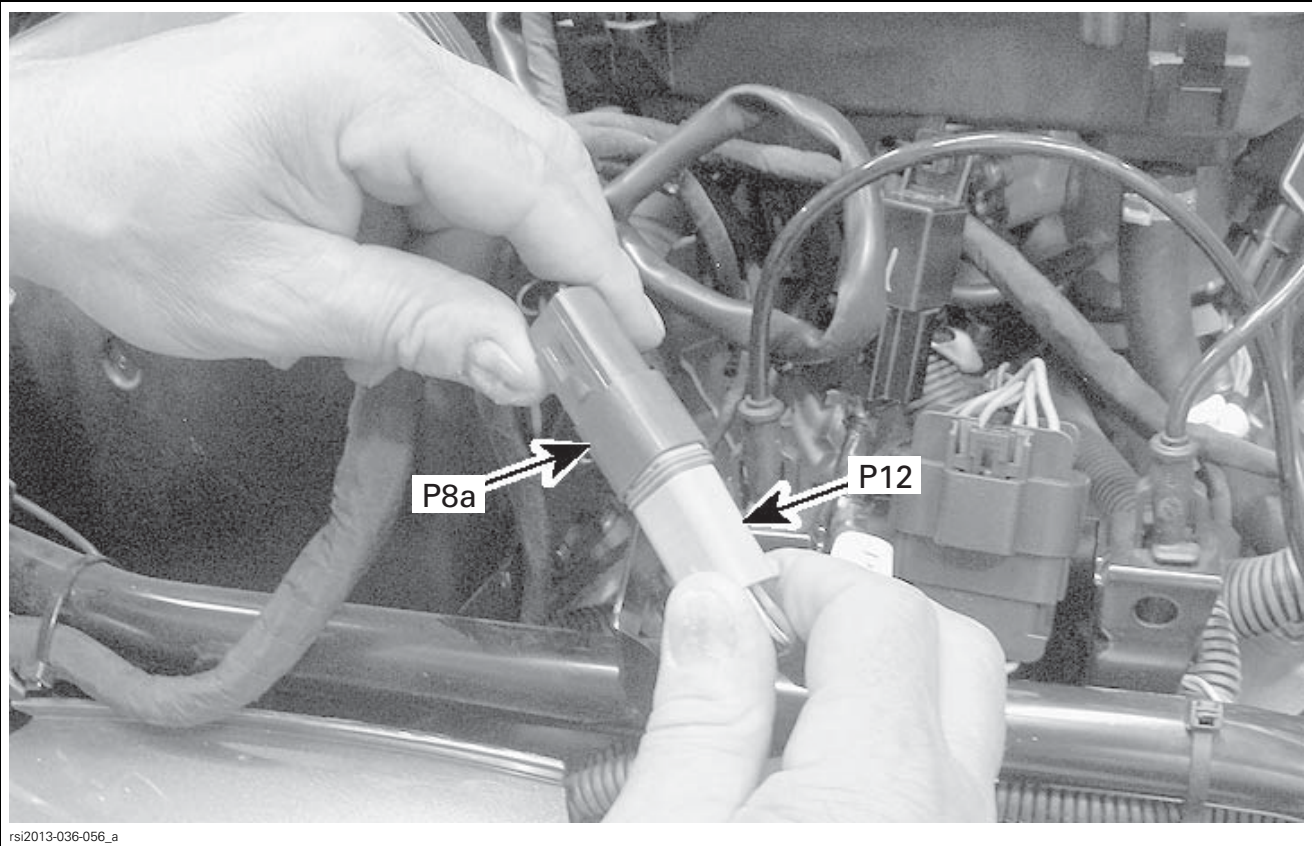

rsi2013-036-056_a

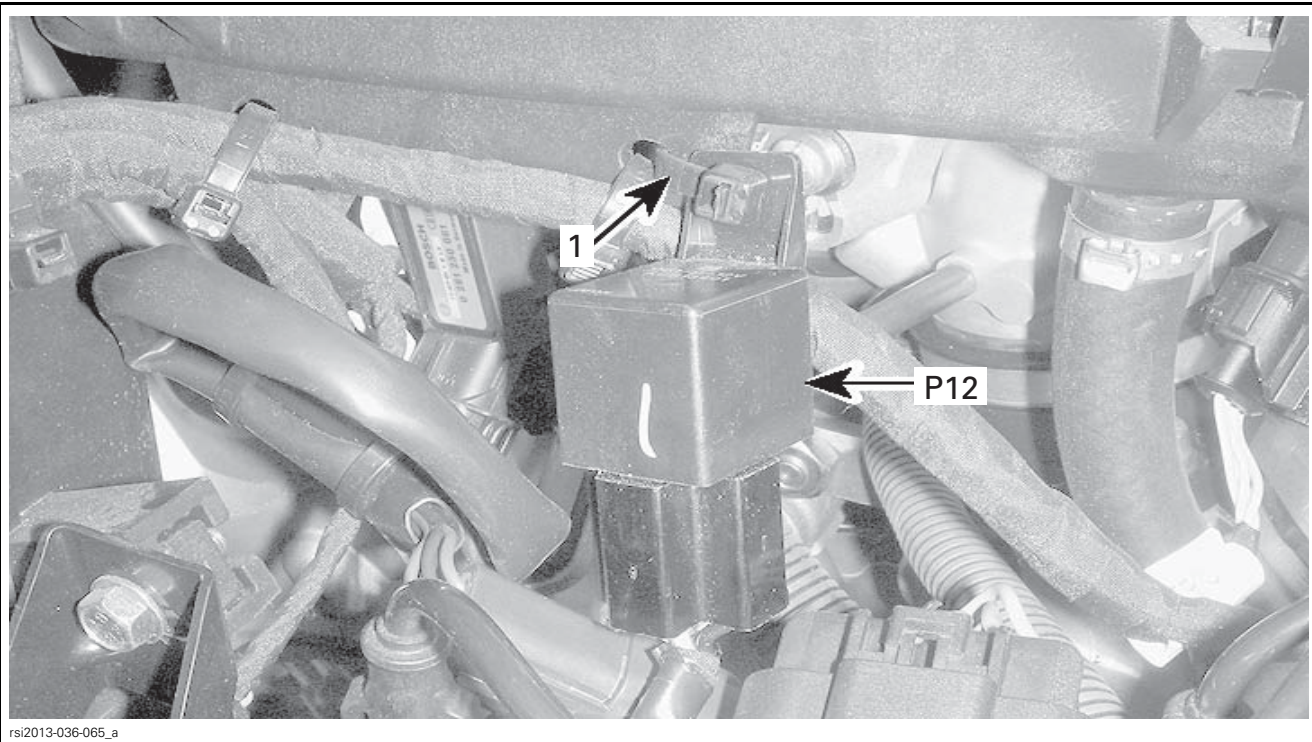

rsi2013-036-065_a

1. Locking tie

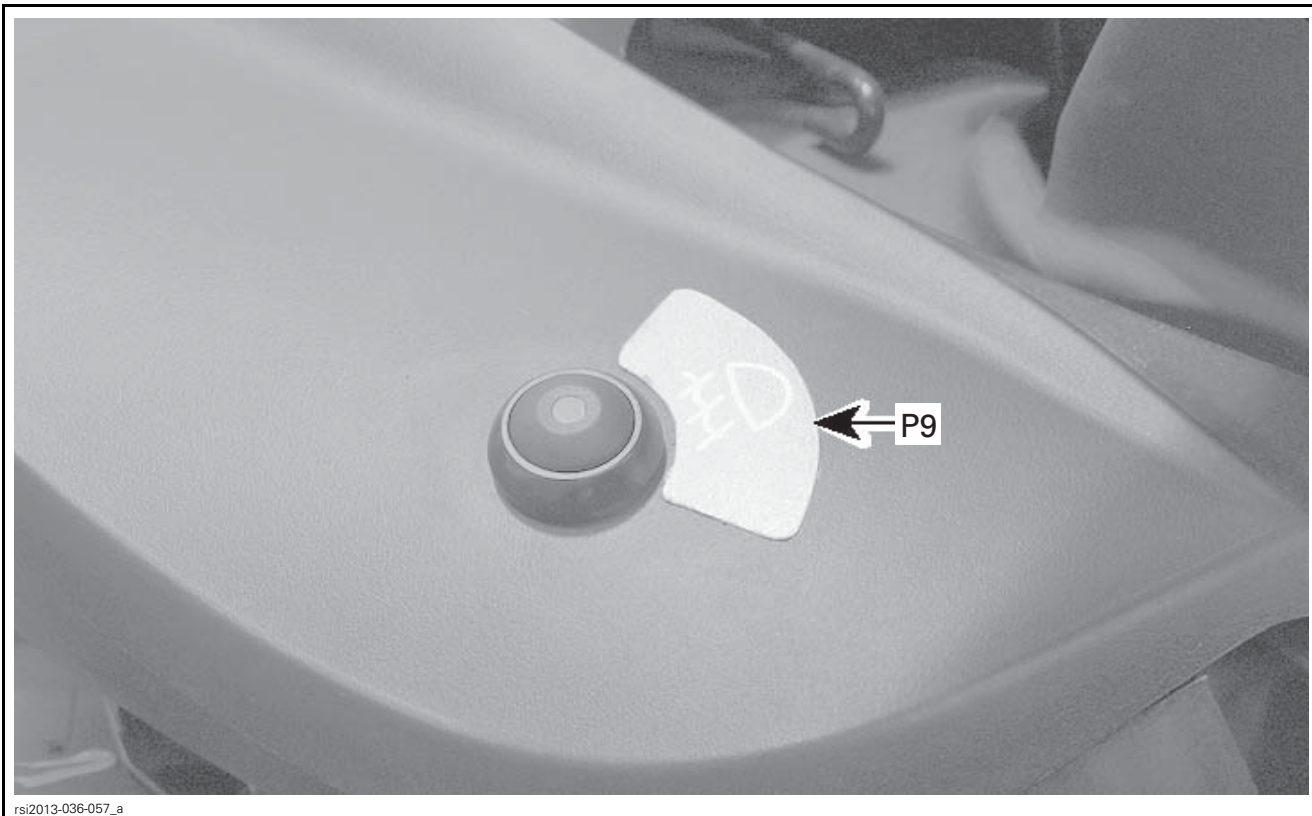

rsi2013-036-057_a

Ensure template is to scale/
S'assurer que le gabarit est à l'échelle

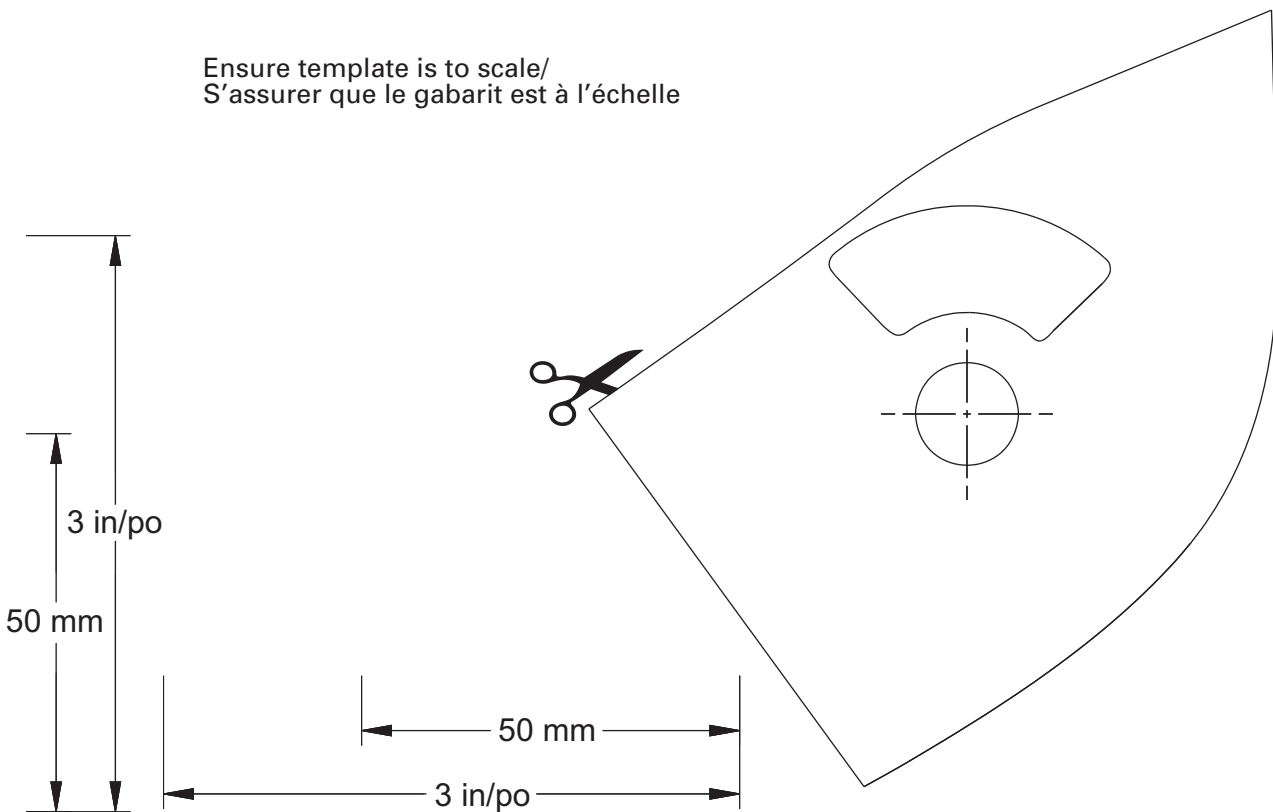

rsi2008-014-011_a